

Flowtron Mosquito PowerTrap®

Model MT-125

Operating Instructions



⚠ IMPORTANT ⚠
KEEP OUT OF REACH OF CHILDREN.
READ THE LABEL & OPERATING INSTRUCTIONS
BEFORE USING.
Please retain operating instructions for future reference.

WARRANTY

Flowtron warrants your Mosquito PowerTrap to be free from defects in materials or workmanship under normal use and service for one year from date of original purchase. All parts which are defective will be replaced free of charge. Any implied warranties, including the implied warranty of merchantability are also limited in duration to the one year period from the original purchase date.

The provisions of this warranty shall not apply to any product which has been subject to misuse, neglect or accident, nor which is used for a purpose for which it is not designed, or which shall have been repaired or altered in any way so as to adversely affect its performance and reliability. Service by unauthorized parties voids your warranty. Warranty covers only the original purchaser. Commercial and/or professional use is excluded from warranty coverage.

Flowtron neither assumes nor authorizes any person to assume for it any other liability in connection with its product. No responsibility is assumed for any consequential damages that may result from the use of a Flowtron product, nor for damages due to accident, abuse, lack of responsible care, the affixing of any unauthorized attachment, loss of parts or subjecting this unit to any but the specified voltage.

If the unit fails to operate during the warranty period, send the product, along with purchase receipt showing purchase date and description of the problem to: Flowtron Service Center, 15 Highland Avenue, Malden, MA 02148. Transportation costs for returning any defective product are the responsibility of the consumer.

This warranty gives you specific legal rights, and you may also have other rights which vary from state to state.

Flowtron Outdoor Products, 15 Highland Ave, Malden, MA 02148 • 1-800-343-3280

Table of Contents

	Page
Carton Contents	1
Your Enemy – the Mosquito	2
How Your Mosquito PowerTrap Works.....	2
Rules for Safe Use	2
Placement	3
Installation	3
Operation	3
Maintenance	4
Troubleshooting Chart	4
Accessories	4

Carton Contents

Qty.	Description
1	Mosquito PowerTrap
1	Power Pack and Wire
1	Catch Tray
1	Octenol Cartridge
1	Post
1	Tank Strap
1	Tank Stand
1	Owners Manual

Unpacking Instructions

Your Flowtron Mosquito PowerTrap has been carefully packed at the factory to prevent damage during shipment. Carefully open the carton and:

1. Remove contents from carton.
2. Check parts against carton content list.

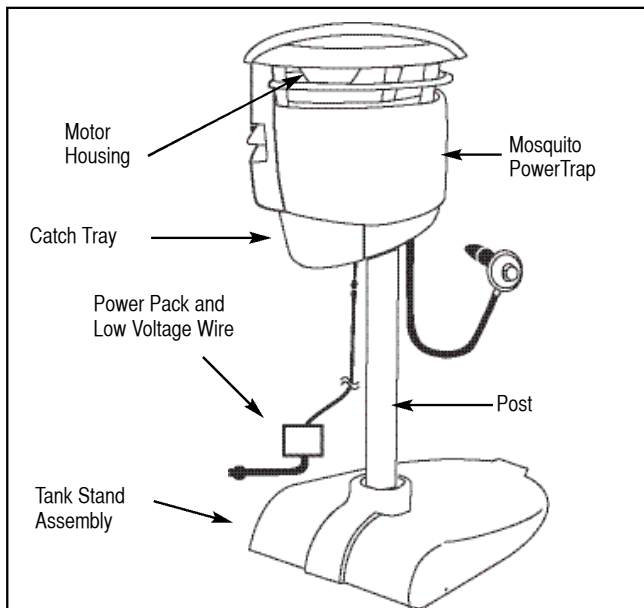

Your Enemy – the Mosquito

There are some 2,700 species (different kinds of mosquitoes) in the world with about 170 species in North America alone.

Most mosquitoes live and die close to where they hatch, although some can travel miles (kilometers) in search of a host. Only the female mosquito bites as she requires a blood meal to produce eggs.

Mosquitoes require standing water in aquatic habitats including fresh water, salt water marshes, brackish water or in water found in containers, old tires, tree holes, even flower pots. The female mosquito lays her eggs on the surface of the water and if conditions are right the eggs hatch and become larvae, then pupae and finally adult mosquitoes; all in 10 to 14 days.

Both male and female mosquitoes feed regularly on nectar obtained from flowers, but females require blood to produce fertile eggs. Therefore, she must find a human or animal host to blood feed before she can lay her eggs.

Most mosquitoes that emerge in the wild never come in contact with humans but obtain blood from birds and other animals. Mosquito species that breed around the home remain close to where they hatched and are regarded as pests and carriers of disease.

Mosquitoes in search of a blood meal use visual, thermal and olfactory (odour) stimuli to locate a host. Of these, olfactory cues are the most important.

Out of the more than 100 compounds detected in human breath only two have been isolated and identified as significant mosquito attractants; **carbon dioxide** (CO₂) and **octenol** (1-OCTEN-3-OL). These attractants serve as long-range airborne attractants and can be detected by mosquitoes at distances of 100 feet to 125 feet (30 - 40 m).

At close range, body heat, moisture and lactic acid serve as terminal attractants. Certain species show strong preferences for biting different parts of the human body. This is thought to be related to local skin temperature and lactic acid output.

The attractiveness of different persons to mosquitoes varies substantially. Men are bitten more readily than women, adults more often than children and larger persons attract more mosquitoes perhaps because of their greater relative heat and carbon dioxide output.

How Your Flowtron Mosquito PowerTrap® Works

The revolutionary new Flowtron Mosquito PowerTrap® replicates the attractants mosquitoes use to locate, bite and annoy humans. It does this by producing carbon dioxide, heat and moisture and combining these stimuli with octenol to create an attractant to mosquitoes.

Your Flowtron Mosquito PowerTrap®:

- Replicates the human attractants of respiration, odor and body heat.
- Converts readily available propane gas into heat, moisture and carbon dioxide, the acknowledged leading mosquito attractants emitted by humans.
- Produces a powerful vacuum to draw mosquitoes into a convenient, removable catch tray where they quickly dehydrate and die for safe, clean disposal.
- Contains state-of-the-art computer controlled electronics.

The Flowtron Mosquito PowerTrap® does away with ultraviolet lights and high voltage killing grids. Most importantly, it attracts and kills only female mosquitoes.

Flowtron Mosquito PowerTrap® uses an exclusive catalyst that converts air and propane gas into heat, moisture and carbon dioxide. It does this in an efficient, effective and economical manner. The catalyst converter is completely safe, flameless and **never needs to be replaced**.

⚠ Rules for Safe Use ⚠

1. Use outdoors only. Install the unit a minimum of 10 feet (3 m) from buildings and other structures.
2. Never place fingers or insert any object into the unit while it is operating.
3. Always disconnect unit from its power source and wait for unit to cool before handling, moving or servicing.
4. This device was designed for use with propane gas. Never attempt to use any other fuel, including liquid fuels or natural gas. Fire or damage to your Flowtron PowerTrap could result.
5. Always operate the unit in an upright position to prevent damage to the CO₂ generator.
6. Do not abuse the power pack. Never carry the power pack by its cord or yank it to disconnect it from a receptacle. Keep power cord away from heat, oil and sharp edges.
7. Store indoors when not in use. Remove propane tank from unit before storing and store tank outdoors in a well ventilated space.

Placement

Your Mosquito PowerTrap® is site specific and placement is critical for successful results.

Your PowerTrap emits a plume of octenol-enhanced carbon dioxide which mosquitoes follow in their search for a blood meal. Mosquitoes fly up-wind toward the source of the plume in their attempt to locate a host. Since the direction of the plume is dependent upon the direction of the wind, your unit should be positioned so its attractant outlet faces downwind.

Female mosquitoes also feed on moisture laden nectar and fruit juices when not in search of a blood meal. They are usually found in shade; around flowers, trees, bushes and other vegetation; and adjacent to standing water.

For best results locate your unit 20 to 30 feet (6 - 10 m) away from areas of human activity in a location near (but not in) bushes, wooded areas, or adjacent to standing water (other than swimming pools). Select a location which will result in the carbon dioxide plume blowing toward the area where mosquitoes are likely to hide and emerge. **A proper location will ensure that mosquitoes encounter the plume and follow it up-wind to the Flowtron Mosquito PowerTrap® before they detect the presence of humans. See Illustration 1.**

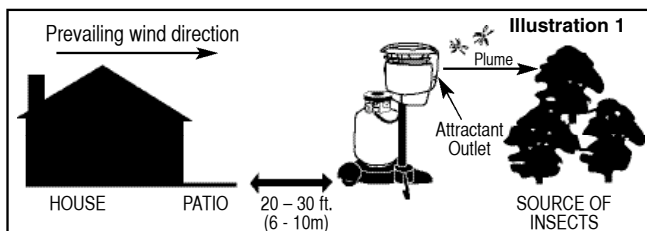

Assembly

1. Insert one end of the post into the post opening at the front of the tank stand. Insert opposite end of post into the post opening located at the bottom of the PowerTrap®. Align unit in relation to the tank stand. **See Illustration 2.**
2. Place a 20 lb. tank on the tank stand. **Secure tank to post by attaching tank strap around post and tank handle.**
3. Install catch tray by first inserting the rear of the tray into the housing. Then push in upper part of the latch and raise front of catch tray into place. **See Illustration 3.**
4. Position and screw the Power Pack to either an outside or inside wall adjacent to an electrical outlet (screws not provided). Run the low voltage wire either above or below ground from the Power Pack to the unit.

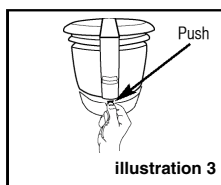
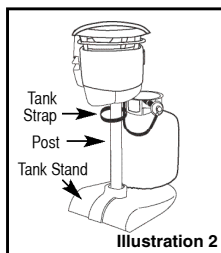

Connect Propane Regulator

1. Remove the plastic dust cover from your propane tank valve.
2. Screw the propane regulator coupling located on the end of the propane hose onto the tank valve by turning the black threaded coupling clockwise until tight. Hand tighten only. See Illustration 4.

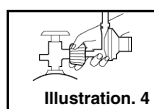

Note: Gas will not flow unless connection is tight. Tighten by hand only. Using a wrench or other tool could damage the regulator coupling and could cause a gas leak.

WARNING
Check for gas leaks by wetting the connections with a solution of soap and water and watching for bubbles. If bubbles form or if a bubble grows larger, there is a leak and connection must be tightened.

WARNING
Check for gas leaks every time you disconnect and reconnect a gas fitting.
Be sure there are no sparks or open flame in the area when you check for leaks.
Do not use a liquid propane tank with a damaged valve. Have dented or rusty propane tanks checked by your propane supplier.
Only use regulator supplied with your Flowtron PowerTrap.

Operation

Your Flowtron Mosquito PowerTrap® is fully automatic. It is equipped with a microprocessor which controls all operating functions.

To operate the PowerTrap, plug the power pack into a 120 volt electrical outlet. Plug the low voltage wire into the electrical connector located at the bottom of the PowerTrap. LED's located inside the PowerTrap motor housing will glow red indicating that the unit has begun its start-up cycle. Approximately three minutes later, the fan will come on and run periodically until the start cycle is complete.

The start cycle will be complete when the catalyst has reached normal operating temperature, which takes from 5 to 15 minutes. At this time, the fan will run continuously and the LED lights will change from red to blue. This is an indication that the Mosquito PowerTrap is fully operational and ready to attract and kill mosquitoes.

Fifteen minutes after the unit detects a lack of propane fuel (usually due to an empty propane tank) the LED lights will go from blue to a flashing red. Simply disconnect power and refuel. If the tank is not out of propane and the LED's are flashing red, refer to the troubleshooting chart on page 4.

Auto Re-Start Feature:

In the event of a loss of electrical power while your unit is in operation, the Flowtron Mosquito PowerTrap® will shut down until power is restored. When electrical power is once again available, the unit will automatically re-start with no intervention necessary.

Note: As mosquitoes pass through the fan, most are killed and thrown against the side of the internal screen-lined funnel. Those that escape the fan's killing action end up in the catch tray where they quickly dehydrate and die. For best results remove the funnel and clean the screen each time the propane tank is refilled. See page 4 for instructions for removing the screen-lined funnel and cleaning the screen.

Octenol Cartridge

U.S. Government and university researchers have demonstrated that **octenol** combined with **carbon dioxide** (both components of respiration) are irresistible attractants to mosquitoes.

The Flowtron Mosquito PowerTrap® uses a specially designed time release cartridge containing **octenol** (1-OCTEN-3-OL).

To Install the Octenol Cartridge:

1. Remove the octenol cartridge from the sealed pouch and peel the protective cover from the face of the cartridge. Avoid touching the openings in the cartridge and always wash hands thoroughly after contact.
2. Place the cartridge in the rectangle slot located at the bottom of the plenum. Insert the cartridge with the openings facing inward. See Illustration 5.

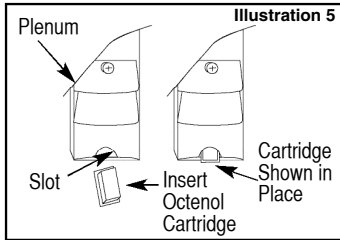

Maintenance

1. After approximately three to four weeks of Mosquito PowerTrap use, the LED lights will flash red indicating a new supply of propane is needed.
2. Replace the octenol cartridge each time the propane tank is refilled.
3. Empty the catch tray periodically to ensure proper air flow through the trap. To remove the catch tray push in on the latch at the front of the catch tray and pull tray down.
4. Remove and clean the screen-lined funnel each time the propane tank is refilled or more often during periods of heavy infestation. To remove funnel, proceed as follows:

Switch unit off and allow it to cool. Remove catch tray.

Push rear of bottom funnel ring up into the unit's housing until front tabs become disengaged from housing. See figure A.

Pull funnel down and forward releasing rear section of upper funnel ring and remove funnel from unit. See figure B.

Remove insect debris from screen surrounding funnel. Wash screen with water and shake off excess water before re-installing.

Re-install funnel by holding funnel at a slight angle and insert the front edge of the upper funnel ring inside of unit's housing. See figure C.

Push funnel upwards and with the rear section of the bottom funnel ring at a slight angle compress funnel until front tabs of bottom funnel ring are up inside of the housing. See figure D.

Release funnel and it will spring into place.

Replace catch tray and re-start unit.

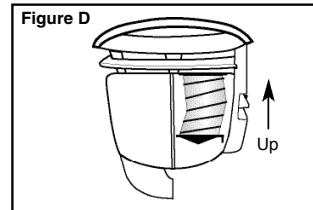
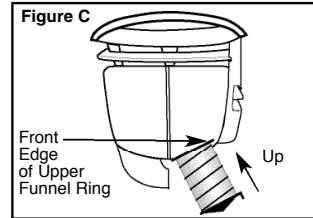
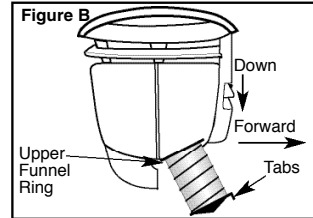
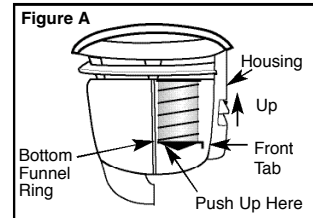

Trouble Shooting Chart

Symptom	Probable Cause	Remedy
Fan and LED lights do not come on periodically when switch is placed to ON position.	No power at outlet Unit not properly connected to its power pack.	Check for electrical power at outlet. Check plug connections between unit and power pack low voltage cord.
The fan does not run continuously and the LED lights do not change to blue after the unit has been on for at least 15 minutes.	Lack of propane Start cycle malfunction.	Same as for LED lights flashing red. Switch unit OFF and then restart.
LED lights are flashing red,	Lack of propane. Propane tank valve closed. Regulator coupling not properly attached.	Refill propane tank. Open tank valve. Check propane regulator coupling for proper engagement and/or leaks.
Not catching mosquitoes when the fan is running, the valve is pulsing and the LED lights are blue.	Funnel end is not over catch tray nozzle opening. Funnel clogged with insect debris. Trap is not located in a productive site. Windy, cool or stormy weather. Current mosquito population not readily attracted to CO ₂ + Octenol.	Engage the funnel end with the catch tray nozzle opening. Clean funnel. See page 7. Move trap to a new site. See placement guidelines in the owner's manual. Wait for conditions more to the mosquito's liking. Notably the day flying Asian tiger Mosquito. Operate the trap with the octenol cartridge removed.

Any problems you encounter that are not corrected by the action recommended in this chart should be referred to the Flowtron Service Department • (800) 343-3280

Accessories

Accessories are available at your local retail outlet or on-line at www.flowtron.com



Octenol Mosquito Attractant: MA-1000
Octenol Mosquito Attractant: MA-1000-6 (six pack)

Makes your Mosquito PowerTrap more effective in attracting mosquitoes and biting flies.



Extension Cord – EC-50

50 foot low voltage extension cord. Allows placement of the Mosquito PowerTrap an additional 50 feet away from the power source.